



























































































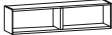

Korpuse Lack - Tiefe 36, 49 und 66 cm

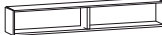
Breite → Höhe ↓	30 cm	40 cm	50 cm	60 cm	80 cm	100 cm ohne Mittelseite	100 cm mit Mittelseite (nur durch- gehende Klappen bzw. Doppel- türen möglich)	120 cm ohne Mittelseite	120 cm mit Mittelseite (nur durch- gehende Klappen bzw. Doppel- türen möglich)	160 cm mit Mittelseite (nur durch- gehende Klappen möglich)
1 1/2 R 18,6 cm	-									
1 R 37,8 cm	-									
1 1/2 R 57,0 cm										-
2 R 76,2 cm										-
2 1/2 R 95,4 cm										-
3 R 114,6 cm										-
3 1/2 R 133,8 cm					-	-	-	-	-	-
4 R 153,0 cm					-	-	-	-	-	-
4 1/2 R 172,2 cm					-	-	-	-	-	-
5 R 191,4 cm					-	-	-	-	-	-
5 1/2 R 210,6 cm					-	-	-	-	-	-
6 R 229,8 cm					-	-	-	-	-	-

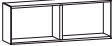
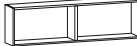
Hinweis:

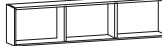
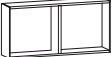
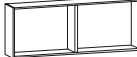
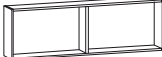
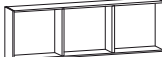
- Abdeckplatten konstruktiv immer erforderlich, **auch bei gestapelten Kombinationen.**
- Tiefe 66 cm wandhängend nicht möglich.

Schiebetürkorpuse Lack/Holz - Tiefe 36 und 49 cm

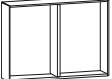
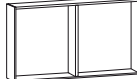
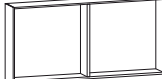
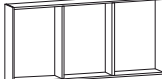
Breite → Höhe ↓	160 cm mit 1 Mittelseite	200 cm mit 1 Mittelseite	240 cm mit 1 Mittelseite	240 cm mit 2 Mittelseiten	
1/2 R 18,6 cm					
1 R 37,8 cm					
1 1/2 R 57,0 cm					
2 R 76,2 cm					
2 1/2 R 95,4 cm					
3 R 114,6 cm					

Hinweis:

- Abdeckplatten konstruktiv immer erforderlich, **auch bei gestapelten Kombinationen.**

Nischenkorpusse mit Gefache Lack/Holz - Tiefe 36 und 49 cm

Breite → Höhe ↓	30 cm	40 cm	50 cm	60 cm	80 cm	100 cm ohne Mittelseite	100 cm mit Mittelseite	120 cm ohne Mittelseite	120 cm mit Mittelseite	160 cm
1 1/2 R 19,2 cm							-		-	-
1 R 38,4 cm							-		-	-
1 1/2 R 57,6 cm							-		-	-
2 R 76,8 cm					-	-	-	-	-	-
2 1/2 R 96,0 cm					-	-	-	-	-	-
3 R 115,2 cm					-	-	-	-	-	-
3 1/2 R 134,4 cm					-	-	-	-	-	-
4 R 153,6 cm					-	-	-	-	-	-
4 1/2 R 172,8 cm	-	-	-	-	-	-	-	-	-	-
5 R 192,0 cm	-	-	-	-	-	-	-	-	-	-
5 1/2 R 211,2 cm	-	-	-	-	-	-	-	-	-	-
6 R 230,4 cm	-	-	-	-	-	-	-	-	-	-

Hinweis:

- Abdeckplatten nicht möglich.

Abdeckplatten Glas/Lack/Holz - für Korpusse in Tiefe 36, 49 und 66 cm

Breite → Korpus	30 cm	40 cm	50 cm	60 cm	80 cm	100 cm ohne Mittelseite	100 cm mit Mittelseite	120 cm ohne Mittelseite	120 cm mit Mittelseite	160 cm mit Mittelseite
Abdeck- platte										

Hinweis:

- Abdeckplatten konstruktiv immer erforderlich, **auch bei gestapelten Kombinationen**.
Ausnahme: Nischenschränke.
- Bei aneinandergereihten Korpusen ist die Abdeckplatte durchgehend bis Breite 360 cm erhältlich.
- Alucobond und Eiche sägerauh **NUR** bis Breite 280 cm erhältlich.

Sockelplatten Lack/Holz - für Korpusse in Tiefe 36, 49 und 66 cm

Breite → Korpus	30 cm	40 cm	49 cm	60 cm	80 cm	100 cm ohne Mittelseite	100 cm mit Mittelseite	120 cm ohne Mittelseite	120 cm mit Mittelseite	160 cm mit Mittelseite
Sockel- platte										

Hinweis:

- Je Korpus eine Sockelplatte.

Sockelplatten Lack/Holz - für Schiebetürkorpusse in Tiefe 36 und 49 cm

Breite → Korpus	160 cm mit 1 Mittelseite	200 cm mit 1 Mittelseite	240 cm mit 1 Mittelseite	240 cm mit 2 Mittelseiten	
Sockel- platte					

Hinweis:

- Je Korpus eine Sockelplatte.

Wandaufhängungen - für Korpusse in Tiefe 36 und 49 cm

Breite → Korpus	30 cm	40 cm	49 cm	60 cm	80 cm	100 cm ohne Mittelseite	100 cm mit Mittelseite	120 cm ohne Mittelseite	120 cm mit Mittelseite	160 cm mit Mittelseite
Wand- aufhängung										

Hinweis:

- Je Korpus ein Wandaufhängebeschlag.
- Tiefe 66 cm wandhängend nicht möglich



































































Wandaufhängungen - für Schiebetürkorpusse in Tiefe 36 und 49 cm

Breite → Korpus	160 cm mit 1 Mittelseite	200 cm mit 1 Mittelseite	240 cm mit 1 Mittelseite	240 cm mit 2 Mittelseiten	
Wand- aufhängung					

Hinweis:

- Je Korpus ein Wandaufhängebeschlag.

Drehfronten Glas/Lack/Holz - für Tiefe 36, 49 und 66 cm

Breite → Höhe ↓	30 cm	40 cm	50 cm	60 cm		80 cm	100 cm ohne Mittelseite 2-türig	100 cm mit Mittelseite 2-türig	120 cm ohne Mittelseite 2-türig	120 cm mit Mittelseite 2-türig
	1-türig	1-türig	1-türig	1-türig	2-türig	2-türig				
1 1/2 R 18,9 cm	-	-	-	-	-	-	-	-	-	-
1 R 38,1 cm	-	-	-	-	-	-	-	-	-	-
1 1/2 R 57,3 cm					-					
2 R 76,5 cm					-					
2 1/2 R 95,7 cm					-					
3 R 114,9 cm					-					
3 1/2 R 134,1 cm						-	-	-	-	-
4 R 153,3 cm						-	-	-	-	-
4 1/2 R 172,5 cm						-	-	-	-	-
5 R 191,7 cm						-	-	-	-	-
5 1/2 R 210,9 cm						-	-	-	-	-
6 R 230,1 cm						-	-	-	-	-

Hinweis:

- Griff Standard Quickout.
- Optional können vertikale Griffleisten geplant werden.
- Bei Doppeltüren ist der Griff immer an der rechten Tür.

Klappenfronten Glas/Lack/Holz - für Korpusse in Tiefe 36, 49 und 66 cm

Breite → Höhe ↓	30 cm	40 cm	50 cm	60 cm	80 cm	100 cm	100 cm	120 cm	120 cm	160 cm
						ohne Mittelseite	mit Mittelseite	ohne Mittelseite	mit Mittelseite	mit Mittelseite
1/2 R 18,9 cm	-									
1 R 38,1 cm	-									
1 1/2 R 57,3 cm	-					-		-		-

Hinweis:

- Klappenfronten sind im Standard mit Quickout ausgestattet.
- Optional können horizontale Kurzgriffe/Griffleisten geplant werden.

Schubfronten Glas/Lack/Holz - für Korpusse in Tiefe 36, 49 und 66 cm

Breite → Höhe ↓	30 cm	40 cm	50 cm	60 cm	80 cm	100 cm	100 cm	120 cm	120 cm	160 cm
						ohne Mittelseite	mit Mittelseite	ohne Mittelseite	mit Mittelseite	mit Mittelseite
1/2 R 18,9 cm	-						-		-	2x 80er Schub
1 R 38,1 cm	-						-		-	2x 80er Schub

Hinweis:

- Schubfronten sind im Standard mit Quickout ausgestattet.
- Optional können horizontale Kurzgriffe/Griffleisten geplant werden.
- Schubkastengefache möglich.
- CD- und DVD-Profile möglich ab Korpushöhe 1 Raster.





























































Schiebetürfronten Glas/Lack/Holz - für Tiefe 36 und 49 cm

Breite → Korpus Höhe ↓	160 cm mit 1 Mittelseite	200 cm mit 1 Mittelseite	240 cm mit 1 Mittelseite	240 cm mit 2 Mittelseiten	
	1 Schiebetür möglich Breite 80 cm	1 Schiebetür möglich Breite 100 cm	1 Schiebetür möglich Breite 120 cm	1 oder 2 Schiebetüren möglich Breite 80 cm	
1/2 R 18,9 cm					
1 R 38,1 cm					
1 1/2 R 57,3 cm					
2 R 76,5 cm					
2 1/2 R 95,7 cm					
3 R 114,9 cm					

Hinweis:

- Schiebetüren sind immer grifflos.

Innenschubkasten für Schiebetürkorpusse Lack/Holz - für Tiefe 36 und 49 cm

Breite → Höhe ↓	160 cm mit 1 Mittelseite Innenschubkasten Breite 80 cm	200 cm mit 1 Mittelseite Innenschubkasten Breite 100 cm	240 cm mit 1 Mittelseite Innenschubkasten Breite 120 cm	240 cm mit 2 Mittelseiten Innenschubkasten Breite 80 cm	
1/2 R 18,6 cm	1 Schub 	1 Schub 	1 Schub 	1 Schub 	
1 R 37,8 cm	1 Schub 2 Schübe  	1 Schub 2 Schübe  	1 Schub 2 Schübe  	1 Schub 2 Schübe  	
1 1/2 R 57,0 cm	2 Schübe 3 Schübe  	2 Schübe 3 Schübe  	2 Schübe 3 Schübe  	2 Schübe 3 Schübe  	
2 R 76,2 cm	2 Schübe 3 Schübe   4 Schübe 	2 Schübe 3 Schübe   4 Schübe 	2 Schübe 3 Schübe   4 Schübe 	2 Schübe 3 Schübe   4 Schübe 	
2 1/2 R 95,4 cm	3 Schübe 4 Schübe   5 Schübe 	3 Schübe 4 Schübe   5 Schübe 	3 Schübe 4 Schübe   5 Schübe 	3 Schübe 4 Schübe   5 Schübe 	
3 R 114,6 cm	3 Schübe 4 Schübe   5 Schübe 6 Schübe  	3 Schübe 4 Schübe   5 Schübe 6 Schübe  	3 Schübe 4 Schübe   5 Schübe 6 Schübe  	3 Schübe 4 Schübe   5 Schübe 6 Schübe  	

Hinweis:

- Schubkastengefache möglich.
- CD- und DVD-Profile möglich ab Korpushöhe 1 Raster.

WICHTIG:

- Wenn ein Innenschubkasten-Set nicht in voller Korpushöhe geplant wird, ist oberhalb des letzten Schubs konstruktiv ein Holzfach erforderlich. Glasfach nicht möglich.

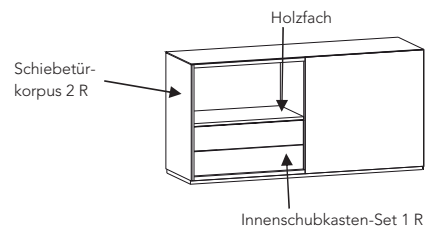

Interieur - für Korpusse in Tiefe 36, 49 und 66 cm

Breite → Korpus	30 cm	40 cm	50 cm	60 cm	80 cm	100 cm	100 cm	120 cm	120 cm	160 cm
						ohne Mittelseite	mit Mittelseite	ohne Mittelseite	mit Mittelseite (2x Breite 60 cm)	mit Mittelseite (2x Breite 80 cm)
Glasfach										
Holzfach										
Lochblech- fach	-	-								
Bodenplatte	-	-								
Rückwand- spiegel	-	-								
Innenschub- kasten	-	-								
Tablar- auszug	-	-								
CD-Profil	-	-								
DVD-Profil	-	-								

Einsätze für Schubkästen - für Korpusse NUR in Tiefe 49 cm/ab Breite 40 cm

Bodenplatte	Wellen	Besteck	12 Fächer	10 Fächer	Kaffee- Kapseln	Wein	Uhren	Schatulle		

Kabelführung - für Korpusse in Tiefe 36, 49 und 66 cm

Breite → Korpus	30 cm	40 cm	50 cm	60 cm	80 cm	100 cm	100 cm	120 cm	120 cm	160 cm
						ohne Mittelseite	mit Mittelseite	ohne Mittelseite	mit Mittelseite (2x Breite 60 cm)	mit Mittelseite (2x Breite 80 cm)
Kabelkanal horizontal	-	-								
Kabelkanal vertikal	-	-								
Kabelausfräsung in Abdeckplatte	-	-								
Kabeldurchlass in Abdeckplatte										
Elektro- verteilerbox	-	-								
Steckdosen- blende	-	-	-							
Kabelblende KABL	-									
Kabelblende KABL S										
Lüftungs- gitter	-	-	-							

Elektrisches Zubehör/Beleuchtung - für Korpusse in Tiefe 36, 49 und 66 cm

Innen- beleuchtung	Innen- beleuchtung	Trafo	Funkschalter- Set	Infrarotauge	Kabelbox					
mit Akku 				mit Standfuß 	24 cm 40 cm 					

























Raumteilerrückwände Glas/Lack/Holz - für Tiefe 36, 49 und 66 cm

Breite → Höhe ↓	30 cm	40 cm	50 cm	60 cm	80 cm	100 cm ohne Mittelseite	100 cm mit Mittelseite	120 cm ohne Mittelseite	120 cm mit Mittelseite	160 cm mit Mittelseite
1/2 R 18,9 cm	-									
1 R 38,1 cm										
1 1/2 R 57,3 cm										-
2 R 76,5 cm										-
2 1/2 R 95,7 cm										-
3 R 114,9 cm										-
3 1/2 R 134,1 cm					-	-	-	-	-	-
4 R 153,3 cm					-	-	-	-	-	-
4 1/2 R 172,5 cm					-	-	-	-	-	-
5 R 191,7 cm					-	-	-	-	-	-
5 1/2 R 210,9 cm					-	-	-	-	-	-
6 R 230,1 cm					-	-	-	-	-	-

Hinweis:

- Raumteilerrückwände immer in voller Korpushöhe und Korpusbreite.

Raumteilerrückwände für Schiebetürkorpusse Glas/Lack/Holz - Tiefe 36 und 49 cm

Breite → Höhe ↓	160 cm mit 1 Mittelseite Rückwand 2-teilig (je Breite 80 cm)	200 cm mit 1 Mittelseite Rückwand 2-teilig (je Breite 100 cm)	240 cm mit 1 Mittelseite Rückwand 2-teilig (je Breite 120 cm)	240 cm mit 2 Mittelseiten Rückwand 3-teilig (je Breite 80 cm)	
1/2 R 18,9 cm					
1 R 38,1 cm					
1 1/2 R 57,3 cm					
2 R 76,5 cm					
2 1/2 R 95,7 cm					
3 R 114,9 cm					

Griffleisten/Kurzgriff horizontal - für Klappen-/ und Schubfronten

für → Frontbreite	30 cm	40 cm	50 cm	60 cm	80 cm	100 cm	100 cm	120 cm	120 cm	160 cm
						ohne Mittelseite	mit Mittelseite	ohne Mittelseite	mit Mittelseite	mit Mittelseite
Griffleiste	X	—	—	—	—	—	—	—	—	—
Kurzgriff	-	-	-	-	-	-	-	-	-	-































Griffleisten/Kurzgriff vertikal - für Drehtüren

für Fronthöhe ↓	Griff- leiste	Kurz- griff
1 1/2 R 57,3 cm		l
2 R 76,5 cm		l
2 1/2 R 95,7 cm		l
3 R 114,6 - 203,1 cm		l

Hinweis:

- Bei Drehtüren (2-türig) nur eine vertikale Griffleiste/Kurzgriff an der rechten Front.
- Bitte Griffposition angeben (oben/mitte/unten).
- Bitte Griffausführung angeben.





Paneelsystem 90K Lack/Holz

Breite → Höhe ↓	100 cm	120 cm	140 cm	160 cm	180 cm	200 cm	240 cm	280 cm		
1 1/2 R 57,6 cm	-	-								
2 R 76,8 cm	-	-								
2 1/2 R 96,0 cm										
3 R 115,2 cm										
3 1/2 R 172,8 cm			-	-	-	-	-	-		









Hinweis:

- Es können mehrere Holzpaneele übereinander montiert werden.
In diesem Fall wird ein durchgehender Montagerahmen geliefert.

Elektrisches Zubehör/Beleuchtung - für Paneelsystem 90K

Paneelkanten- beleuchtung	Paneelkanten- beleuchtung	RGB Steuergerät	Infrarotauge						
LED-Band 	RGB-LED-Band 	mit Fernfern- bedienung 	im Paneel eingebaut 						





Fußgestell - Tiefe 36, 49 und 66 cm

Wangenhöhe → für Gesamt-Korpusbreite ↓	14 cm	23 cm
110 cm - 210 cm	mindestens 2 Wangen erforderlich 	mindestens 2 Wangen erforderlich 
220 cm - 240 cm	mindestens 2 Wangen und 1 Stützfuß erforderlich 	mindestens 2 Wangen und 1 Stützfuß erforderlich 
250 cm - 320 cm	mindestens 3 Wangen erforderlich (alternativ kann mittig 1 Stützfuß geplant werden) 	mindestens 3 Wangen erforderlich (alternativ kann mittig 1 Stützfuß geplant werden) 
330 cm - 360 cm	mindestens 4 Wangen erforderlich (alternativ können mittig 2 Stützfüße geplant werden) 	mindestens 4 Wangen erforderlich (alternativ können mittig 2 Stützfüße geplant werden) 



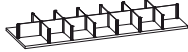

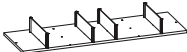
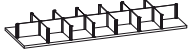
Hinweis:

- Optional können zusätzliche Wangen pro Fußgestellrahmen eingeplant werden.
- Bitte Ausführung der Wangen angeben.
- Fußgestellrahmen nur erhältlich in alufarbig.



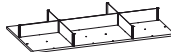
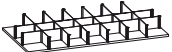
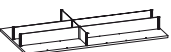

Schubkastengefache für Aussenschubkasten - Tiefe 36 cm

Set Varianten → für Korpusbreite ↓	Set Q quadratische Einteilung	Set H horizontale Einteilung	Set V vertikale Einteilung
40 cm - 80 cm 1 Set erforderlich 1 Bodenplatte erforderlich	SG1.Q.23+SGB.32.23 	SG1.H.23+SGB.32.23 	SG1.V.23+SGB.32.23 
100 cm - 160 cm 1 Set erforderlich 1 Bodenplatte erforderlich (bei Breite 160 cm: 2x80er Bodenplatte)	SG2.Q.23+SGB.32.23 	SG2.H.23+SGB.32.23 	SG2.V.23+SGB.32.23 

Schubkastengefache für Aussenschubkasten - Tiefe 49 cm

Set Varianten → für Korpusbreite ↓	Set Q quadratische Einteilung	Set H horizontale Einteilung	Set V vertikale Einteilung
40 cm - 80 cm 1 Set erforderlich 1 Bodenplatte erforderlich	SG1.Q.36+SGB.32.36 	SG1.H.36+SGB.32.36 	SG1.V.36+SGB.32.36 
100 cm - 160 cm 1 Set erforderlich 1 Bodenplatte erforderlich (bei Breite 160 cm: 2x80er Bodenplatte)	SG2.Q.36+SGB.32.36 	SG2.H.36+SGB.32.36 	SG2.V.36+SGB.32.36 

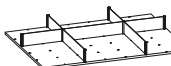
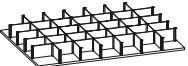

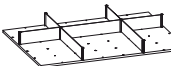

Schubkastengefache für Aussenschubkasten - Tiefe 66 cm

Set Varianten → für Korpusbreite ↓	Set Q quadratische Einteilung	Set H horizontale Einteilung	Set V vertikale Einteilung
40 cm - 80 cm 1 Set erforderlich 1 Bodenplatte erforderlich	SG1.Q.51+SGB.32.51 	SG1.H.51+SGB.32.51 	SG1.V.51+SGB.32.51 
100 cm - 160 cm 1 Set erforderlich 1 Bodenplatte erforderlich (bei Breite 160 cm: 2x80er Bodenplatte)	SG2.Q.51+SGB.32.51 	SG2.H.51+SGB.32.51 	SG2.V.51+SGB.32.51 

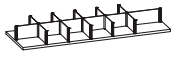
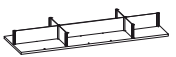

Hinweis:

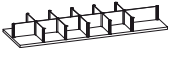
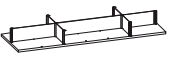
- Die Basis ist eine schwarz lackierte Bodenplatte, welche mit Ankerpunkten für Stifte versehen ist.
- Zwischen zwei Stiften wird ein Streifen eingesetzt.
- Einzelset's zur individuellen Zusammenstellung möglich.
(Stifte im 10er Pack; Streifen verschiedene Längen je im 5er Pack erhältlich)

Schubkastengefache für Innenschubkasten im Schiebetürschrank - Tiefe 36 cm

Set Varianten → für Innenschubkastenbreite ↓	Set Q quadratische Einteilung	Set H horizontale Einteilung	Set V vertikale Einteilung
80 cm 1 Set erforderlich 1 Bodenplatte erforderlich	SG1.Q.21+SGB.32.21 	SG1.H.21+SGB.32.21 	SG1.V.21+SGB.32.21 
100 cm - 120 cm 1 Set erforderlich 1 Bodenplatte erforderlich	SG2.Q.21+SGB.32.21 	SG2.H.21+SGB.32.21 	SG2.V.21+SGB.32.21 

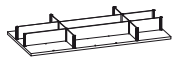
Schubkastengefache für Innenschubkasten im Schiebetürschrank - Tiefe 49 cm

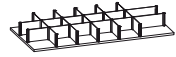
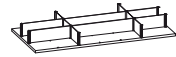
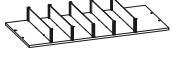
Set Varianten → für Innenschubkastenbreite ↓	Set Q quadratische Einteilung	Set H horizontale Einteilung	Set V vertikale Einteilung
80 cm 1 Set erforderlich 1 Bodenplatte erforderlich	SG1.Q.31+SGB.32.31 	SG1.H.31+SGB.32.31 	SG1.V.31+SGB.32.31 
100 cm - 120 cm 1 Set erforderlich 1 Bodenplatte erforderlich	SG2.Q.31+SGB.32.31 	SG2.H.31+SGB.32.31 	SG2.V.31+SGB.32.31 

Hinweis:

- Die Basis ist eine schwarz lackierte Bodenplatte, welche mit Ankerpunkten für Stifte versehen ist.
- Zwischen zwei Stiften wird ein Streifen eingesetzt.
- Einzelset's zur individuellen Zusammenstellung möglich.
(Stifte im 10er Pack; Streifen verschiedene Längen je im 5er Pack erhältlich)