

PRODUKTINFORMATION 07-2022

# ALEA

WOHNEN

---

Kettmaker

BEISPIELE

SCHRÄNKE ANEINANDERGEREIHT

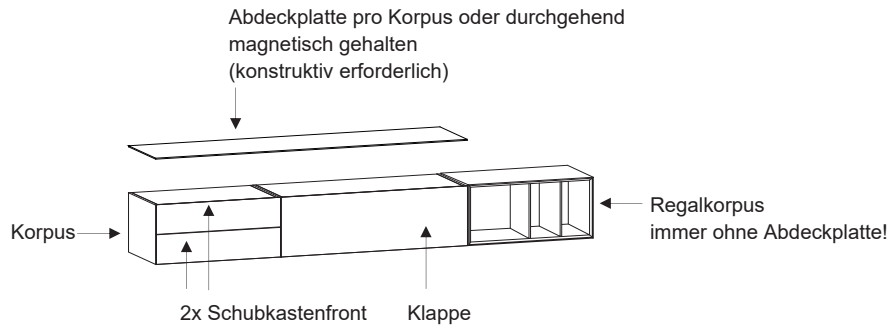

SCHRÄNKE GESTAPELT

Abdeckplatten bei gestapelten Korpusen - PRO KORPUS - konstruktiv erforderlich!

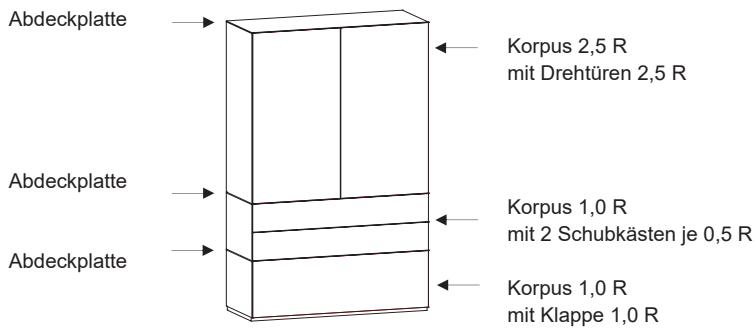

SCHRANK MIT FRONT-/FUNKTIONSWECHSEL

Bei Front-/Funktionswechsel Zwischenboden konstruktiv erforderlich!

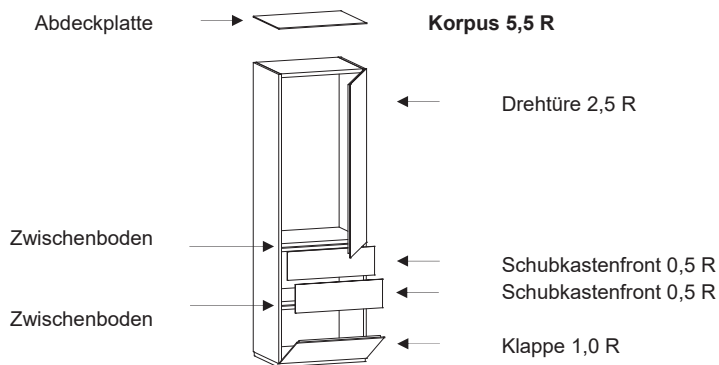

FUGENPLATTEN

HORIZONTAL  
zwischen gestapelten Korpusen

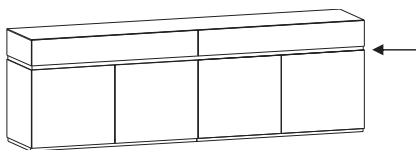

VERTIKAL  
zwischen aneinandergereihten Korpusen

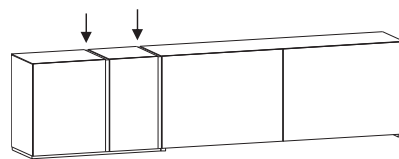



PLANUNGSHINWEISE:



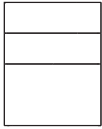
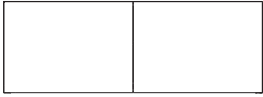

- Griffvarianten siehe FRONTEN
- Fußvarianten siehe Register FUSSVARIANTEN

**GRIFFVARIANTEN**

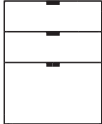

**OHNE GRIFF - PUSH TO OPEN**  
Standard

			
<b>TÜRENSCHRÄNK</b>	<b>KLAPPENSCHRÄNK</b>	<b>SCHUBKASTENSCHRÄNK</b>	<b>SCHIEBETÜRENSCHRÄNK</b>

**KURZGRIFF HORIZONTAL**  
B: 8  
Aufpreis

			
<b>POSITION TÜRENSCHRÄNK</b> links/rechts oben/unten wählbar	<b>KLAPPENSCHRÄNK</b> mitte oben	<b>SCHUBKASTENSCHRÄNK</b> mitte oben	<b>SCHIEBETÜRENSCHRÄNK</b> links/rechts oben

**GRIFFLEISTE HORIZONTAL**  
B: 30 - 160  
Aufpreis

nicht möglich			
<b>POSITION TÜRENSCHRÄNK</b>	<b>KLAPPENSCHRÄNK</b> oben	<b>SCHUBKASTENSCHRÄNK</b> oben	<b>SCHIEBETÜRENSCHRÄNK</b>

**GRIFFLEISTE VERTIKAL**  
H: 1 - 3 R  
Aufpreis

	nicht möglich	nicht möglich	nicht möglich
<b>POSITION TÜRENSCHRÄNK</b> links/rechts - Bei Doppeltüren ist die Griffleiste (in Fronthöhe) immer an der rechten Türe (links nicht möglich). - Bei Türen höher 3,0 R unten beginnend.	<b>KLAPPENSCHRÄNK</b>	<b>SCHUBKASTENSCHRÄNK</b>	<b>SCHIEBETÜRENSCHRÄNK</b>

**KURZGRIFF VERTIKAL**  
H: 8 cm  
Aufpreis

	nicht möglich	nicht möglich	nicht möglich
<b>POSITION TÜRENSCHRÄNK</b> links/rechts oben - Bei Doppeltüren ist der Griff immer an der rechten Türe (links nicht möglich).	<b>KLAPPENSCHRÄNK</b>	<b>SCHUBKASTENSCHRÄNK</b>	<b>SCHIEBETÜRENSCHRÄNK</b>

**PLANUNGSHINWEISE:**

R = RASTER  
1,0 RASTER = 38,4 CM

Artikel erhältlich in TIEFE: 30 36 49 66

<input type="checkbox"/>	<input type="checkbox"/>	<input type="checkbox"/>	<input type="checkbox"/>
<input type="checkbox"/>	<input type="checkbox"/>	<input type="checkbox"/>	<input type="checkbox"/>
<input type="checkbox"/>	<input type="checkbox"/>	<input type="checkbox"/>	<input type="checkbox"/>
<input type="checkbox"/>	<input type="checkbox"/>	<input type="checkbox"/>	<input type="checkbox"/>

**KORPUSSE**

OHNE / MIT MITTELSEITE  
M = mit Mittelseite

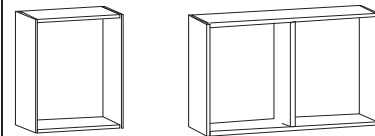

R	H	B															
		30	40	50	60	60	80	100	100	120	120	140	160	200	240		
0,5	18,6		■	■	■		■	■	■	■	■	■	■				
1,0	37,8	■	■	■	■		■	■	■	■	■	■	■				
1,5	57,0	■	■	■	■		■	■	■	■	■						
2,0	76,2	■	■	■	■		■	■	■	■	■						
2,5	95,4	■	■	■	■		■	■	■	■	■						
3,0	114,6	■	■	■	■		■	■	■	■	■						
3,5	133,8	■	■	■	■												
4,0	153,0	■	■	■	■												
4,5	172,2	■	■	■	■												
5,0	191,4	■	■	■	■												
5,5	210,6	■	■	■	■												
6,0	229,8	■	■	■	■												

**DREHTÜREN**

1-TÜRIG / 2-TÜRIG

- 1T = 1-türig  
- 2T = 2-türig

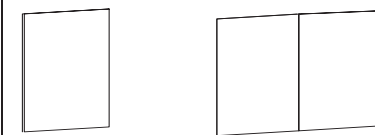

R	H	B															
		30	40	50	60	60	80	100	100	120	120	140	160	200	240		
1,0	38,1	1T	1T	1T	1T	2T	2T	2T		2T							
1,5	57,3	■	■	■	■	■	■	■		■							
2,0	76,5	■	■	■	■	■	■	■		■							
2,5	95,7	■	■	■	■	■	■	■		■							
3,0	114,9	■	■	■	■	■	■	■		■							
3,5	134,1	■	■	■	■	■											
4,0	153,3	■	■	■	■	■											
4,5	172,5	■	■	■	■	■											
5,0	191,7	■	■	■	■	■											
5,5	210,9	■	■	■	■	■											
6,0	230,1	■	■	■	■	■											

**VITRINTÜREN**

1-TÜRIG / 2-TÜRIG

1T = 1-türig  
2T = 2-türig

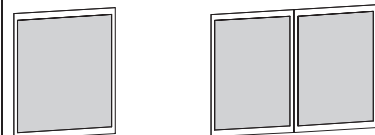

R	H	B															
		30	40	50	60	60	80	100	100	120	120	140	160	200	240		
1,5	57,3	1T	1T	1T	1T	2T	2T	2T		2T							
2,0	76,5	■	■	■	■	■	■	■		■							
2,5	95,7	■	■	■	■	■	■	■		■							
3,0	114,9	■	■	■	■	■	■	■		■							
3,5	134,1	■	■	■	■	■											

**KLAPPEN**

ANSCHLAG UNTEN



R	H	B															
		30	40	50	60	60	80	100	100	120	120	140	160	200	240		
0,5	18,6		■	■	■		■	■		■		■	■				
1,0	37,8		■	■	■		■	■		■		■	■				
1,5	57,0		■	■	■		■	■		■		■	■				

**SCHUBKÄSTEN**

1 SCHUB / 2 SCHÜBE

- 1S = 1 Schub  
- 2S = 2 Schübe

(ein Frontstück, 2 Schubkästen, mittig geteilt)



R	H	B															
		30	40	50	60	60	80	100	100	120	120	140	160	200	240		
0,5	18,6	1S	1S	1S	1S		1S	1S				1S	2S	2S			
1,0	37,8	□	■	■	■		■	■				■	■	■			

**PLANUNGSHINWEISE:**

R = RASTER  
 1,0 RASTER = 38,4 CM

Artikel erhältlich in TIEFE: 30 | 36 | 49 | 66

<input type="checkbox"/>			
<input type="checkbox"/>	<input type="checkbox"/>	<input type="checkbox"/>	
<input type="checkbox"/>	<input type="checkbox"/>	<input type="checkbox"/>	<input type="checkbox"/>
<input type="checkbox"/>	<input type="checkbox"/>	<input type="checkbox"/>	<input type="checkbox"/>

**AKUSTIKSCHRÄNKE  
 MIT AKUSTIKKLAPPE**

R H  
 0,5 18,6  
 1,0 37,8

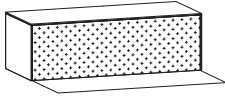
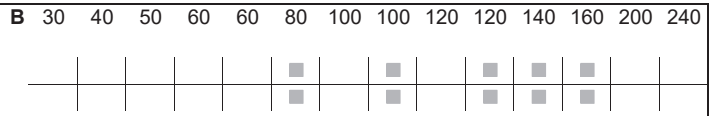

**TV-DREHSÄULENSCHRÄNKE  
 MIT AKUSTIKKLAPPE**

R H  
 0,5 18,6  
 1,0 37,8

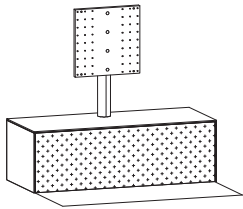
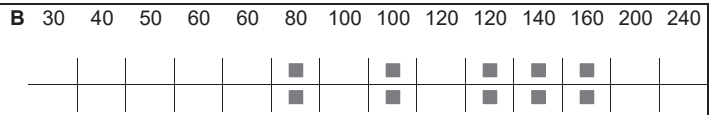

**TV-DREHSÄULENSCHRÄNKE  
 MIT KLAPPE**

R H  
 0,5 18,6  
 1,0 37,8

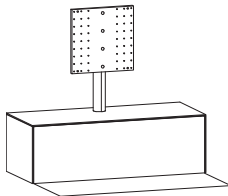
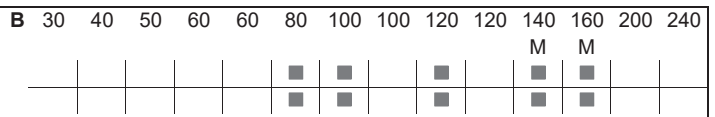

**PLANUNGSHINWEISE:**

R = RASTER  
1,0 RASTER = 38,4 CM

Artikel erhältlich in TIEFE: 30 | 36 | 49 | 66

<input type="checkbox"/>			
<input type="checkbox"/>	<input type="checkbox"/>	<input type="checkbox"/>	
<input type="checkbox"/>	<input type="checkbox"/>	<input type="checkbox"/>	<input type="checkbox"/>
<input type="checkbox"/>	<input type="checkbox"/>	<input type="checkbox"/>	<input type="checkbox"/>

**PLANFRONTSCHIEBETÜRSCHRÄNKE  
MIT 1 MITTELSEITE**

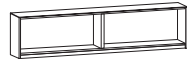
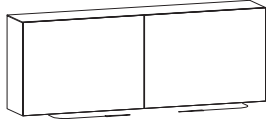

R	H
1,5	57,0
2,0	76,2
2,5	95,4
3,0	114,6

B	30	40	50	60	60	80	100	100	120	120	140	160	200	240
												1M	1M	1M
												<input type="checkbox"/>	<input type="checkbox"/>	<input type="checkbox"/>
												<input type="checkbox"/>	<input type="checkbox"/>	<input type="checkbox"/>
												<input type="checkbox"/>	<input type="checkbox"/>	<input type="checkbox"/>
												<input type="checkbox"/>	<input type="checkbox"/>	<input type="checkbox"/>

**PLANFRONTSCHIEBETÜRSCHRÄNKE  
MIT 3 MITTELSEITEN**

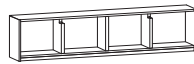
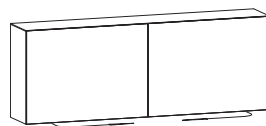

R	H
1,5	57,0
2,0	76,2
2,5	95,4
3,0	114,6

B	30	40	50	60	60	80	100	100	120	120	140	160	200	240
													3M	3M
													<input type="checkbox"/>	<input type="checkbox"/>
													<input type="checkbox"/>	<input type="checkbox"/>
													<input type="checkbox"/>	<input type="checkbox"/>
													<input type="checkbox"/>	<input type="checkbox"/>

**TV-REGALKORPUS**

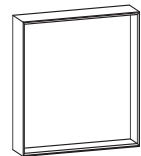

R	H
2,5	96,0
3,0	115,2

B	30	40	50	60	60	80	100	100	120	120	150	160	200	240
											<input type="checkbox"/>	<input type="checkbox"/>	<input type="checkbox"/>	
											<input type="checkbox"/>	<input type="checkbox"/>	<input type="checkbox"/>	

**FUGENPLATTEN HORIZONTAL**

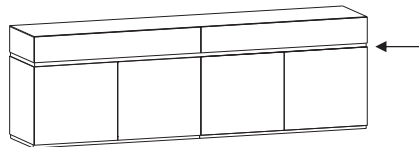

B	30 - 360
H	3,2

für T 36 und 49

**FUGENPLATTEN VERTIKAL**

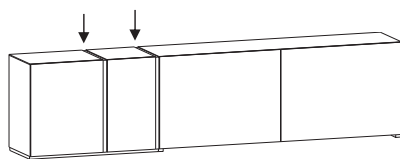

R	H	B
0,5	18,6	3,2
1,0	37,8	
1,5	57,0	
2,0	76,2	
2,5	95,4	
3,0	114,6	
3,5	133,8	

für T 36 und 49





























































**PLANUNGSHINWEISE:**

R = RASTER  
1,0 RASTER = 38,4 CM

Artikel erhältlich in TIEFE: 30 | 36 | 49 | 66

<input type="checkbox"/>	<input type="checkbox"/>	<input type="checkbox"/>	

**REGALKORPUSSE INKL. GEFACHE**

R	B H	30	40	50	60	80	100	120	140	160
0,5	19,2									
1,0	38,4									
1,5	57,6									
2,0	76,8									
2,5	96,0									
3,0	115,2									
3,5	134,4									
4,0	153,6									
4,5	172,8									
5,0	192,0									
5,5	211,2									
6,0	230,4									

**PLANUNGSHINWEISE:**

--

R = RASTER  
1,0 RASTER = 38,4 CM

Artikel erhältlich in TIEFE: 30 | 36 | 49 | 66

<input type="checkbox"/>	<input type="checkbox"/>	<input type="checkbox"/>	

**REGALKORPUSSE DETAILÜBERSICHT - MÖGLICHE POSITIONEN VON ZUSÄTZLICHEN REGALSEITEN**

R	B	H	30	40	50	60	80	100	120	140	160
0,5	19,2										
1,0	38,4										
1,5	57,6										
2,0	76,8										
2,5	96,0										
3,0	115,2										
3,5	134,4										
4,0	153,6										
4,5	172,8										
5,0	192,0										
5,5	211,2										
6,0	230,4										

**PLANUNGSHINWEISE:**



## FUSSVARIANTEN

## FUSSGLEITER SCHWARZ

## STANDARD - ohne Aufpreis

Korpuse bis 3,5 R Höhe inkl. Fußgleiter

## ALEA / SOMA

H: 2,5

B: 30-240

T: 30/36/37/49/50/66/67

Anzahl Fußgleiter: 

B: 40-80	4 Stück
B: 100-160	6 Stück

## SOCKELPLATTE

pro Korpus

H: 3,0

B: 30-240

T: 30/36/37/49/50/66/67



## SOCKELRAHMEN

durchgehend

H: 7,0

B: 100-240

T: 49/50/66/67



## FUSSGESTELL MIT WANGEN

pro Korpus ODER durchgehend

H: 13,5

B: 110-360

T: 36/37/49/50/66/67

Anzahl Wangen: 

B: 110-210	2 Stück
B: 220-320	3 Stück
B: 330-360	4 Stück

## GITTERGESTELL

pro Korpus ODER durchgehend

H: 19,9

B: 40-160

T: 36/37/49/50

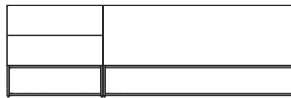

H: 39,1

B: 40-160

T: 36/37/49/50

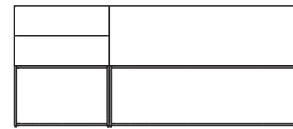

## RUNDROHRGESTELL

pro Korpus ODER durchgehend

H: 35,7

B: 120/180/240

T: 36/37/49/50

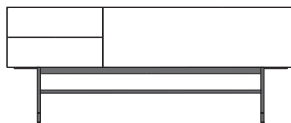

## WANDHÄNGUNG

pro Korpus

B: 30-240

T: 30/36/37/49/50



## PLANUNGSHINWEISE:

Fußgleiter:

- bei gestapelten Kombinationen bis max. Gesamthöhe 3,5 R möglich

Planfrontschiebetürschränke:

- Nur Sockelplatte möglich.

- Fußgestell mit Wangen nur für T 49/50 möglich!

- Planfrontschiebetürschränke bitte nicht mehr als 20 cm vom Boden entfernt aufhängen.  
(Grund: Beschlag ist sichtbar.)

Gitter-/Rundrohrgestell:

- Max. 2 Korpuse pro Gestell

**TIEFE 36 / 37 / 35 CM**

B: 40 - 160

**Flexible Organisation:**

Die variabel verschiebbaren Schubkasteneinsätze ermöglichen eine Einteilung ganz nach Ihrem Bedarf.

**FÜR AUSSENSCHUBKASTEN 0,5 R**



- In den Schubkasten können zusätzlich Schalen platziert werden.
- Um ein komfortables Schieben der Schalen zu erreichen, muss der Schubkasten mit einer Filzeinlage ausgestattet werden.
- Auf die Filzeinlage können die Schalen gesetzt werden.

**FILZEINLAGE**



- In voller Schubkastenbreite.

**ZUBEHÖR**



②

①

Schale

- Auf Wunsch kann weiteres Zubehör in die Schalen geplant werden.

- ① Filzboden für Schale
- ② Filzeinlage 2-teilig (Holz)

Maße von Schale:  
BxTxH in cm: 23,3 x 12,1 x 4,2

**BEISPIEL: SCHUBKASTEN B 120**

4 Schalen (Anordnung längs)  
+ 2 Einlagen 2-teilig

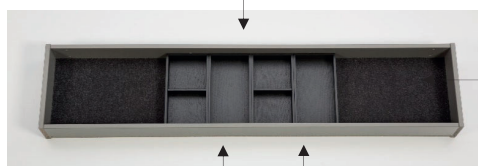

Filzeinlage B 120

2 Schalen (Anordnung längs)

Durch Verschieben einzelner Schalen nach links und/oder rechts entstehen neue Einteilungen.



**PLANUNGSHINWEISE:**

Artikel erhältlich in TIEFE: 5 | 9 | |  
 ■ | ■ | |

**PANEEL SYSTEM 90 K**

mit Montagerahmen aus Aluminium

**Zur Aufnahme von Korpusen, TV's und Wandborden geeignet.**

Paneele können nebeneinander gereiht oder übereinander gestapelt werden.

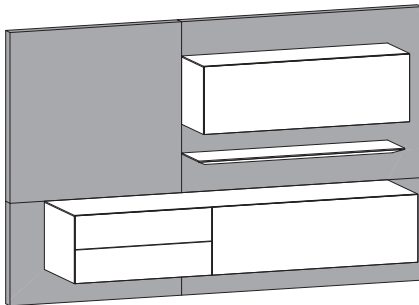

R	H	B	40	60	80	100	120	140	150	160	180	200	220	240	260	280
1,5	57,6							■		■	■	■	■	■	■	■
2,0	76,8							■		■	■	■	■	■	■	■
2,5	96,0					■	■	■		■	■	■	■	■	■	■
3,0	115,2					■	■	■		■	■	■	■	■	■	■
4,0	172,8					■	■									

Paneelkanten auf Gehrung abgekantet

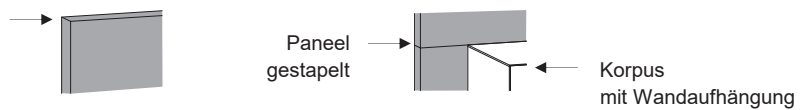

**FLÄCHENPANEEL**

Befestigung per Keilleisten

**Korpuse können NICHT an Flächenpaneel befestigt werden.**

Befestigung von Wandborden und TV's möglich.

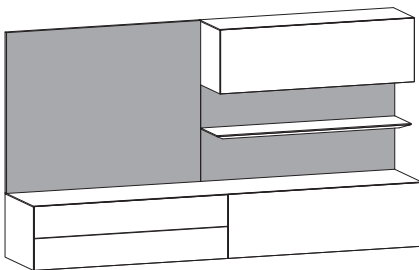

R	H	B	40	60	80	100	120	140	150	160	180	200	220	240	260	280
1,5	57,6		■	■	■	■	■	■		■	■	■	■	■	■	■
2,0	76,8		■	■	■	■	■	■		■	■	■	■	■	■	■
2,5	96,0		■	■	■	■	■	■		■	■	■	■	■	■	■
3,0	115,2		■	■	■	■	■	■		■	■	■	■	■	■	■

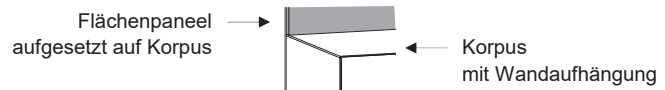

**TV PANEEL**

**NUR zur Befestigung von TV's geeignet.**

Kanten nach hinten abgeschrägt.

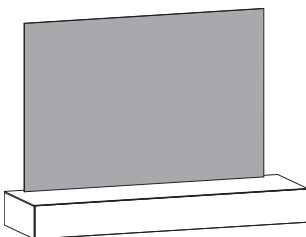

R	H	B	40	60	80	100	120	140	150	160	180	200	220	240	260	280
2,0	76,8						■									
2,5	96,0						■	■	■	■						

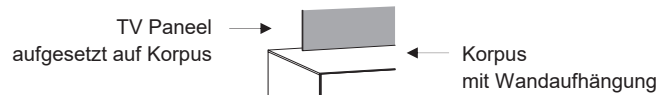

**PLANUNGSHINWEISE:**

- Kabelführung hinter Paneel System 90K, Flächenpaneel und TV-Paneel möglich.
- Bei Möbeln in Verbindung mit Flächen- oder TV-Paneel benötigt die Abdeckplatte einen Kabelausschnitt.
- Optional Hinterkantenbeleuchtung LED Multiwhite 3 möglich. Schaltbar per Funkfernbedienung.

Artikel erhältlich in TIEFE:	28	29		
	■	■		

**WANDBORD 31**

Belastung max. 15 kg / lfm.

freihängend, inkl. Wandaufhängung

Wandbordbeleuchtung NUR in Verbindung mit Paneel möglich  
(Beleuchtung: Einbau unten).

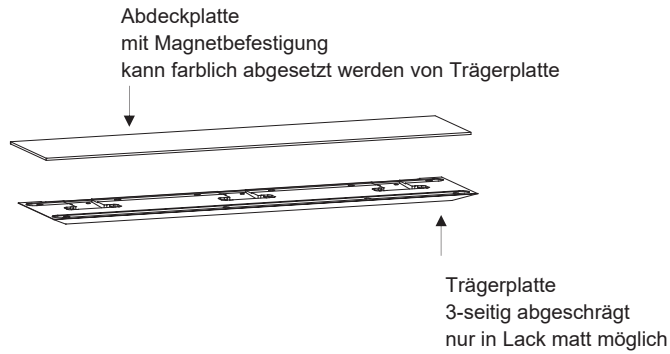
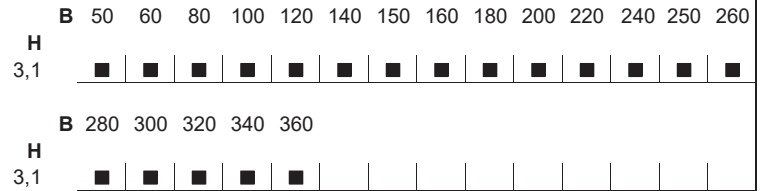

**WANDBORD 32**

Belastung max. 10 kg / lfm.

Wandbordbeleuchtung nicht möglich.

freihängend, inkl. Wandaufhängung

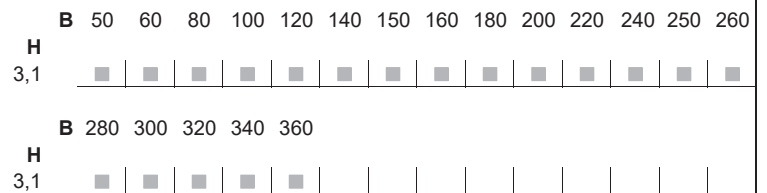

**PLANUNGSHINWEISE:**

Entwicklung und Design:

Kettnaker-Team

Modelle und Namen geschützt.

Alle Rechte bei Wolfgang Kettnaker.

Kettnaker behält sich spätere Änderungen vor, insbesondere wenn sie dem Fortschritt dienen oder eine Verbesserung bedeuten.

Irrtümer vorbehalten.

Stand 05.05.2022

Kettnaker GmbH & Co. KG

Manufaktur für Möbel

Bussenstraße 30

88525 Dürmentingen

Deutschland

Tel. +49 (0) 7371 95 93-0

Fax +49 (0) 7371 95 93-20

[www.kettnaker.com](http://www.kettnaker.com)

[info@kettnaker.com](mailto:info@kettnaker.com)